

# Role Playing

One of the best ways to learn how to do something is through **guided practice**. To gain skill in doing physical exams, students need to practice examining persons with different sicknesses. To learn how to carry out a home health visit, they need to actually visit different families. To become effective in helping people solve problems, they need to practice solving real problems in a community. There is no substitute for experience.

Yet some sort of preparation is essential. It would not be fair to have students examine a sick person without first learning how. Classroom study about ‘what to do’ may help. But what is most important is practice.

**Role playing** provides a lively, realistic way of practicing skills that involve working with people. **It is especially useful for training persons who are more used to learning from life than from books.**

By “role playing” we mean that members of a learning group act out real-life situations. Some may pretend to be persons with particular problems or illnesses. Others may play the roles of relatives, health workers, and so on. **Students act out problem-solving situations similar to those they will encounter as health workers in their own villages.**

For role playing, no written script is needed. There is no memorization of parts. Each participant pretends he or she is someone else, and tries to act and speak the way that person would (or should).

Also, few ‘props’ or special objects are needed. Instead, people can represent many objects by *pantomime*. This means they pretend to do things such as knocking on a door, grinding maize, or picking lice out of the hair, without actually using any doors, maize grinders, or lice. This use of imagination adds to the fun. However, a few simple props, objects, and visual aids can be helpful. Some of these will be discussed here, others in Chapter 27.

Role playing gives students a chance to learn about and practice the human aspects of health care.



Touching is an especially important way of showing you care.

**Role playing in the classroom is one of the best ways to bring learning close to real life—and to make it fun.**

## WAYS ROLE PLAYING CAN BE USED IN THE CLASSROOM

Role playing is especially useful for . . .

### developing PRACTICAL SKILLS:

- practice in using the book *Where There Is No Doctor* (finding and using information; using the book to help others learn)
- practice in attending a sick or injured person (diagnosis, treatment, advice about prevention)
- practice in step-by-step solving of problems (use of scientific method)



### developing SOCIAL SKILLS:

- leadership
- home visits
- community organizing
- relating to people with different needs: the sick, the worried, the proud, the dying, children, doctors, authorities, etc.



### developing TEACHING SKILLS:

- looking at different approaches to education (see example on pages 1-17 to 1-23)
- practicing appropriate teaching methods (with mothers, children, etc.)

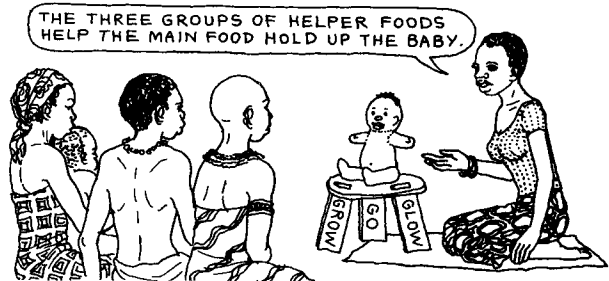

### developing SOCIAL AWARENESS:

- observation and critical analysis of how social and political relations between persons and groups affect people's health and well-being
- looking at attitudes, customs, and patterns of behavior—how they affect people's health; how to help people understand them better
- exploring alternative solutions to different problems
- trying out ideas for public skits or farmers' theater. (Many of the plays discussed in Chapter 27 began with simple role playing in health worker training classes.)



Two women health promoters from Honduras act out problems caused by men's drinking habits. (See p. 27-19 for another example.)

As you will see from the examples in this chapter, a single role play may explore several of the areas listed above. Because it imitates real-life situations, role playing requires students to combine a range of skills and understanding. They must think things through and use their full powers of observation, analysis, imagination, and human feeling.

## SIMPLE VISUAL AND PRACTICAL AIDS FOR USE IN ROLE PLAYING

You will not need many 'props' or special objects for role playing. However, a few simple supplies, visual aids, or pretend instruments sometimes help make role playing more effective. Here are some suggestions:

### 1. PAINTS, COLORED PENCILS, OR MARKING PENS

Use these for marking various signs of illness on the skin.

For example, mark a row of red dots on someone's back. The person plays the role of a child who is brought to a health worker by his mother. The health worker asks questions, examines the child, and tries to determine the cause of the 'sores'. (Judging from the pattern of these bites, they were probably caused by bed bugs.)



### 2. CARDBOARD 'BABIES' AND SIMILAR AIDS

Because so much of health care has to do with small children, it is important to do role plays about children's health problems. If your training program has a good relationship with the local community, children may willingly join in role plays with student health workers. Or mothers may agree to take part with their babies.

However, children and babies are not always available or cooperative. It helps if students make a series of cardboard, cloth, or straw dolls or puppets to be used in role playing.

The more lifelike these doll babies look, the better. They can be used along with other visual aids, such as the pretend thermometers on the next page, for many different role plays.

Spots or sores can be put on a cardboard baby with bits of sticky tape. This way, they can be removed or changed later.

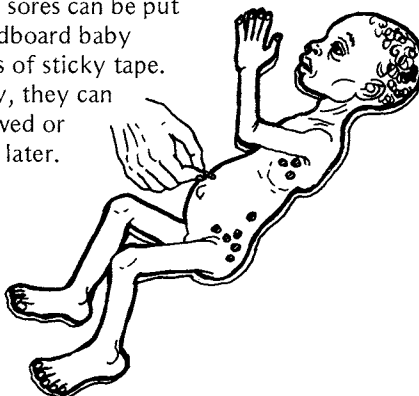

Diarrhea-like stains can be made from dirt, mustard, or *agua de nixtamal* (water in which maize has been soaked for making tortillas).

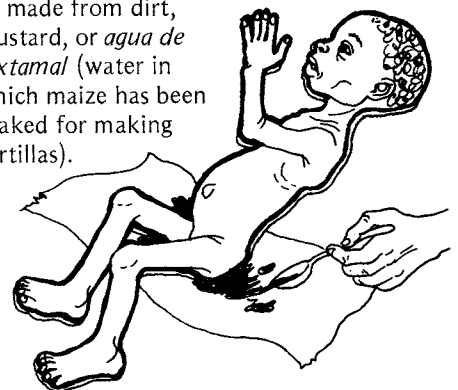

For other ideas of how to use these model babies in role playing and other activities, see pages 11-15, 14-4, and 27-31.

### 3. PRETEND THERMOMETERS

These can be made of cardboard and covered with cellophane or transparent tape. Students can prepare a series of thermometers showing different temperatures, to use in many different role plays.

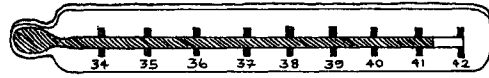

temperature dangerously high  
(see *WTND*, p.76)

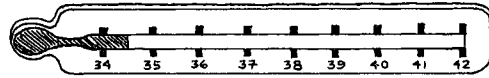

temperature dangerously low  
(see *WTND*, p.273)

HER TEMPERATURE IS DANGEROUSLY LOW. WE MUST TRY TO BRING IT UP BEFORE WE GO ON WITH THE EXAMINATION. WRAP THE CHILD UP AND HOLD HER CLOSE TO YOUR BODY WHILE I FIX SOME HOT WATER BOTTLES.



In role plays, use a cardboard baby, a doll, or a real baby.

Role plays using pretend thermometers provide practice for what to do in different emergencies. When examining a sick baby, it is important that, as soon as a dangerously high or low temperature is observed, the health worker interrupt his examination and take action to lower or raise the baby's temperature.

For example, if the thermometer shows that a baby has a dangerously low temperature, the health worker needs to correct this problem at once. Only after the child is out of immediate danger from the low temperature should the health worker continue with the rest of the examination and treatment.

For more examples of role plays using pretend thermometers, see the class plan starting on p. 5-3.

#### Making 'adjustable thermometers' for role playing:

During their training, try to involve students not only in *using* appropriate teaching materials, but also in *making* and even *inventing* them. (See Ch. 11.) This will help health workers to be more creative when teaching and solving problems with the people in their communities.

During a training course in Ajoya, Mexico, students had been using pretend thermometers like those shown above. Then they were given a new challenge: "Let's see who can make a pretend thermometer with a temperature reading you can change!" Students divided into small groups, and returned an hour later with the inventions on the next page.

EXAMPLES OF ADJUSTABLE THERMOMETERS MADE BY STUDENTS

**“TROMBONE” thermometer—**  
Cut and mark cardboard like this:

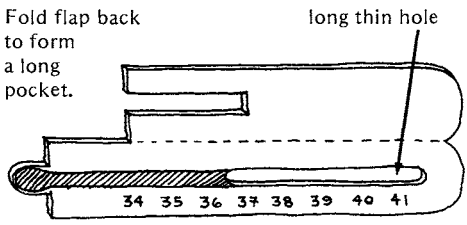

Fold flap back to form a long pocket.

long thin hole

34 35 36 37 38 39 40 41

**FRONT VIEW**

Cut and mark this piece, which fits into pocket.



piece of thin tape or aluminum can to seal pocket

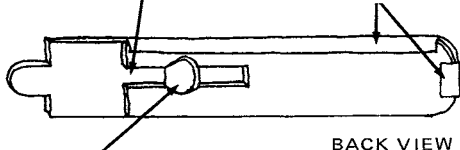

**BACK VIEW**

Slide tab to change temperature reading.

**“WILLOW WHISTLE” thermometer—**  
Made from a green stick of willow or a similar tree.

Loosen the bark by tapping it, and remove it as a single tube.

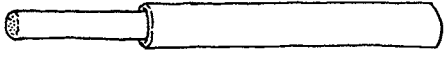

Cut a long thin hole in the bark tube.

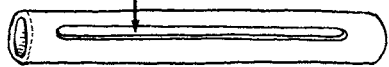

Mark several stripes of different lengths on the stick.



ONE SIDE



OTHER SIDE

Put the stick back into the bark tube, and mark numbers on the bark.



Turn the stick to change temperature reading.

**PENCIL AND TEST TUBE thermometer—**basically the same as the “Willow Whistle,” except that you use a six-sided pencil and a thin glass tube, or blood collection tube.

Scrape the paint off the pencil to a different point on each of the six sides.



Make a long thin hole in a piece of paper, and mark it with degrees.

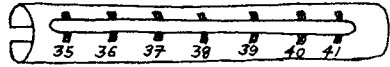

Wrap the paper around the pencil and put it into the tube.



Turn the pencil to change the readings.



You can make one of these adjustable thermometers in a few minutes. Try it. Or see if your students can invent their own.

#### 4. ARTIFICIAL PULSE

Health workers need practice interpreting the meaning of a fast, slow, or changing pulse. Such practice can be gained through role plays by using paper wristbands on which the 'sick person's' pulse is written.

Make a small cut at each end of the band so that it can be fastened around someone's wrist.

The person checking the 'pulse' reads the number on the wristband and uses this information to help make a diagnosis (see p. 14-9).

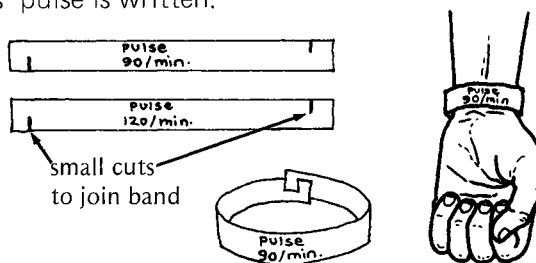

#### Making an adjustable pulse:

An adjustable pulse that the health worker can actually feel and count can be made from the following materials:

- 1 balloon
- 2 rubber bands (or thread)
- 1 strip of cardboard about 5 cm. wide, with long narrow holes cut in it
- 1 I.V. tube, or similar tubing about 1 meter long
- 1 suction bulb

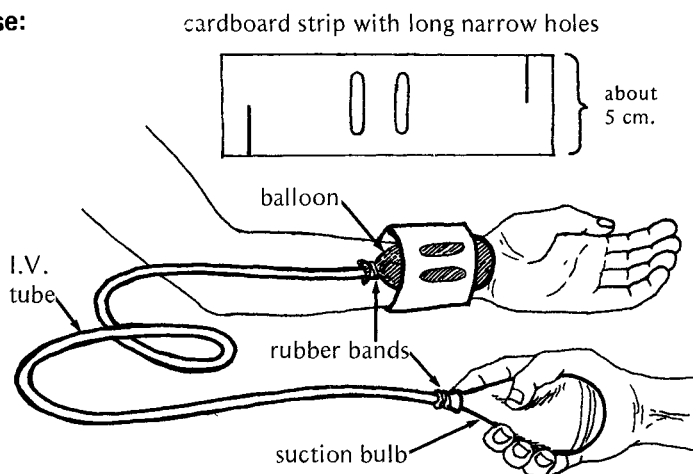

Join the parts as shown to make a bracelet. The holes in the cardboard strip should be in the position of the arteries in the wrist.

The person being examined holds the suction bulb behind his back and squeezes it rhythmically to produce a 'pulse' that is fast or slow, strong or weak, according to the illness being acted out. (This will take practice ahead of time to get it right.)

The person taking the pulse puts her fingers over the 'arteries' and counts the pulses per minute.

This teaching aid can be used in role plays about fever, shock, extreme fear (hysteria), typhoid (see p. 14-9), and many other problems. It not only gives students practice in measuring and comparing different pulse rates, but helps them learn where to find the arteries of the wrist.



suction bulb being squeezed at pulse rate

## ROLE PLAYING FILE CARDS OR LOOSE-LEAF NOTEBOOK

It is a good idea to make a collection of notes on different role plays as you develop them during a training program. This collection can be built upon from course to course, as old role plays are improved and new ones are added. Such a collection serves as a memory bank for experienced instructors and as a gold mine of ideas for new instructors. These ideas should, of course, serve only as a starting point. They can be changed and expanded each time a learning group uses them.

The role plays can be grouped by subjects. For each role play, it helps to also list **learning objectives; actors, materials, and preparations needed; manner of presentation; and questions for group discussion.** Here is an example:

**ROLE PLAY**

Estimated time: ½ hour

**SUBJECT:** Skin problems—infected scabies

**OBJECTIVES:**  
To help students learn to carry out a full physical exam, observe carefully, use their books (and their heads), manage the problem, and give advice to the child's older sister or brother.

**ACTORS:**

- a 2- or 3-year old child (real child if possible)
- child's older sister (played by a student)
- health worker (played by a student)

**MATERIALS:**

- book (*Where There Is No Doctor*)
- 2 beans or marbles
- red and yellow marking pens
- adhesive tape (flesh-colored if possible)
- cardboard thermometer set at 38°



**PREPARATION:**

- Mark the child with typical scabies sores.
- On one wrist put infected scabies sores with yellow centers of 'pus'.
- Draw a faint red line on that same arm (lymph channel).
- Tape two beans or marbles in the armpit.
- Put dirt on child's hands and under his nails.
- Dress the child in long sleeves, or wrap him up so marks will not be seen until he is undressed.

**PRESENTATION:**

- Older sister brings the child to see the health worker.
- The sister says the child has a fever and acts sick. (She does not mention signs of scabies.)
- The health worker does not know what the problem is. He tries to find out by asking questions, but the sister gives little helpful information.
- The health worker takes the temperature (38°C.) and examines the child. (Hopefully, he takes the child's shirt off and finds all the signs.)
- The health worker studies his book, makes the most likely diagnosis, and gives appropriate treatment and preventive advice.

For **QUESTIONS FOR GROUP DISCUSSION**, see the next page.

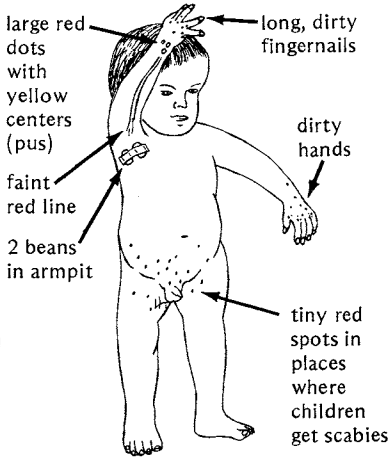

**CAUTION:** When putting on this and similar role plays, be sure the group and the person playing the health worker do not know what the problem is beforehand.

Infected Scabies (continued)

**QUESTIONS FOR GROUP DISCUSSION FOLLOWING THE ROLE PLAY:**

- Why do you think the sister did not mention the child's sores?
- Did the health worker examine the child's throat and ears, and look for other common causes of fever?
- Did the health worker ask about diarrhea and other problems?
- How soon did the health worker figure out the child's problem? What did he overlook? What might he have done better?
- Did the health worker use the book well? Did he use it to help explain the problem to the sister? Did the sister understand?
- Did the health worker examine the sister for scabies, too? Should he have?
- Did the health worker think about whether the sister was old enough or responsible enough to be given the medicines and instructions, or whether he should talk with the mother?
- If the sister was too young and the mother out of reach, did he consider (for example) giving the child a single injection of long-acting penicillin instead of tablets? What are the strengths and weaknesses of such a choice?

- Did the health worker explain what preventive measures to take? Did he suggest treatment for the whole family? Did he explain things simply and clearly? Did he question the sister to make sure she understood?
- Did the health worker notice the child's dirty hands and nails—and give good advice (or cut the child's nails)?
- Did the health worker consider the family's economic position, and give the least expensive medicine for scabies?
- Was the health worker kind to the child and to the child's sister? Did he treat them with respect? As equals?
- Conclusions: What have we learned from this role play? (It may help to list the main points on the blackboard.)



Photo of scabies role play in Mexico, with a village child as the main actor.

**Note:** It is better if these and other questions come mostly from the students—not from the instructor. However, the group leader may need to give suggestions for the kind of questions to ask, especially at first. Later, the students will often think of important questions and concerns that the instructor may have overlooked.

**Fun but serious:** Role playing should be fun—but it also should be taken seriously. Actions and characters may be exaggerated at times, but they should basically be true to the way things and people really are. Whenever possible, role plays should serve to deepen the group's understanding of people and their problems.

## IDEAS FOR ROLE PLAYS

In the rest of this chapter, we give examples of different kinds of role plays. Other examples are found in other parts of this book. Look in the Index under 'Role playing'.



Helping Health Workers Learn 2012  
EXAMPLE OF ROLE PLAYING PLAN

**SUBJECT:** Typhoid Fever

Estimated time  
for role play  
and discussion:  
1 hour

- OBJECTIVES:**
1. To help students develop a systematic approach to problem solving.
  2. To learn how to record vital signs and use them in diagnosing illnesses.
  3. To gain experience in the diagnosis, treatment, and prevention of typhoid fever.

**ACTORS:**

- the sick person
- parents or relatives of the sick person
- one or two health workers

**MATERIALS:**

- a pretend clock with movable hands to show changes in the hour
- a pretend thermometer with adjustable temperature readings (see p. 14-4)
- an adjustable artificial pulse (see p. 14-6)
- a watch with a second hand, or a homemade one-minute timer (see p. 16-7)
- pink marking pen for painting 'rose spots' on skin
- poster paper for making a vital signs chart everyone can see



**PREPARATION:**

- Paint 4 or 6 pink spots—each about 3mm. across—on the chest of the 'sick person'.
- Plan with the 'sick person' and 'parents' how to act the role of a person with typhoid (see *WTND*, p. 189) and what history to give (flash flood, no latrines, work on coastal plantation, etc.—whatever fits your area).
- Advise the 'sick person' and the 'parents' not to provide any of this information unless asked by the 'health workers'.
- Have the 'sick person' practice with the artificial pulse until he can do it at the correct rate.



**PRESENTATION:**





- Parents come in with 'sick person', saying he has a fever and has been getting sicker for several days. Now he is too weak and sick to eat. He is wrapped in a blanket.
- **The students playing health workers have not been told what the illness is.** They try to find out by using their books, asking questions, and examining the 'sick person'.
- The health workers take temperature and pulse, using the pretend thermometer and adjustable artificial pulse. On the first reading they find:

temperature 40<sup>o</sup>C.                      (These readings and those to follow  
pulse 82/min.                              are set by sick person or parents.)

- Because the fever is high, the health workers should ask the parents to uncover the sick person, and give him aspirin and cool water to drink. Together they can put cool, damp cloths on his chest and forehead.
- The health workers should recognize that the pulse is unusually slow for a 40<sup>o</sup> fever. They can check in their books under 'Pulse' (*WTND*, p. 32-33) and find that this may be a sign of typhoid fever.

- Half an hour later (according to the pretend clock, which someone sets ahead), the health workers take the temperature and pulse again. This time they find:
 

temperature 39°C.	(Parents have reset the temperature, and the sick
pulse 88/min.	person speeds up the fake pulse according to plan.)
- The health workers notice that the pulse is faster now, even though the temperature has dropped.
- Health workers may find various clues that lead them to consider typhoid fever (pinkish skin spots—in skin chapter, *WTND*, p. 198; comparison of different ‘fevers’—*WTND*, p. 26; pulse—*WTND*, p. 32). If the health workers are having difficulty, other students in the class—who are also looking in their books—can give suggestions. On page 189 of *WTND*, under ‘Typhoid fever’, they may read that, **“If the pulse gets slower when the fever goes up, the person probably has typhoid.”**
- The health workers make the probable diagnosis based on **history, examination, and tests** (checking fever and pulse several times).
- To check their diagnosis, they continue to take ‘vital signs’ (temperature, pulse, and respiration) every half hour, and they record the results on a simple chart.

 <u>Time</u>	 <u>Temp.</u>	 <u>Pulse</u>	 <u>Respiration</u>
9:00 AM	40°	82/min.	30/min.
9:30 AM	39°	88/min.	28/min.
10:00 AM	38.5°	95/min.	28/min.
10:30 AM	39°	82/min.	30/min.

- By recording the vital signs in this way, students can see how the pulse actually gets slower when the temperature rises—a sign of typhoid. (All students should practice keeping these simple records.)
- The health workers decide on treatment, checking medicines and dosages in the green pages of *WTND*. (Or, if the family can afford it, they may decide to refer the sick person to a nearby hospital.)
- They talk to the family about care of the sick person, the causes, course, and dangers of the disease. They explain what to do to prevent it from spreading.

#### QUESTIONS FOR GROUP DISCUSSION FOLLOWING THE ROLE PLAY:

- Did the health workers go about diagnosing the illness in a reasonable way? How could they have done better? (See Chapter 17 of this book.)
- Did they check for signs and history of other possible illnesses?
- When they found the person’s temperature so high, did they try to lower the fever at once? Once they decided that it was probably typhoid, did they stop giving him aspirin? (Aspirin reduces normal clotting of blood and may increase the danger of hemorrhage in the gut.)
- Did they weigh the advantages and risks of treating the person themselves, or of sending him to a hospital?
- Did they ask if any neighbors had the same illness? Did they consider public health measures?
- Did they explain to the family what to do to prevent the spread of typhoid?
- Was their advice realistic? For example, did they offer to get some neighbors together to help dig the family a safe latrine (or whatever might be appropriate in the area)?
- Did they show sympathy, concern, and respect for the sick person and his family?
- Did the student group observing the role play make suggestions and criticisms in a kind, supportive way? Did the instructor do likewise?
- What different things were learned through the role play? About health care? About teaching? About human behavior? How could the group have learned better?

## DIAGNOSIS GAMES

This is a different sort of role playing. One person acts out a series of similar health problems, one after the other, and the group tries to identify them. Here is an example.

**SUBJECT:** Noticing how a person breathes

**OBJECTIVES:**

1. To help health workers recognize various ways of breathing as signs of different illnesses.
2. To improve students' powers of observation.

**USE:** This game can be played when studying how to examine a sick person or when reviewing different respiratory illnesses.

**METHOD:** The instructor (or a well-prepared student) asks the group if they can guess his 'illness' by the way he breathes. In some cases he may want to give a few additional clues. For example, if students ask him, he might say whether or not he has a fever. Students can use their books to find the illness. After the instructor has demonstrated the different types of breathing, students can take turns demonstrating and testing each other.

1. **WHAT ILLNESS DO YOU THINK I HAVE?**

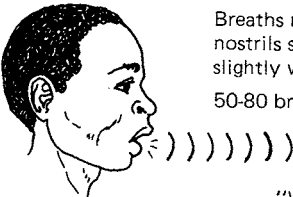

Breaths **rapid and shallow**; nostrils spread and person grunts slightly with each breath; fever. 50-80 breaths/minute

"What is it?"

(Pneumonia? *WTND*, p. 171)
2. Breaths **rapid and deep**; person very weak. 40-80 breaths/min.

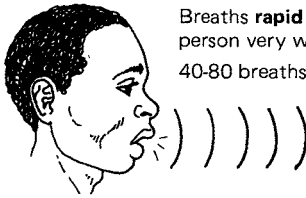

"What is it?"

(Severe dehydration? *WTND*, p. 151)
3. Breaths **rapid and deep**; person very frightened. 60-80 breaths/min.

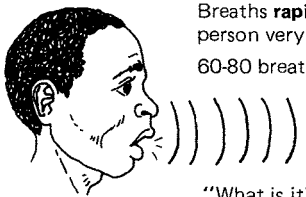

"What is it?"

(Hyperventilation? *WTND*, p. 24)
4. Breaths **rapid** but neither shallow nor deep; high fever. 30-40 breaths/min.

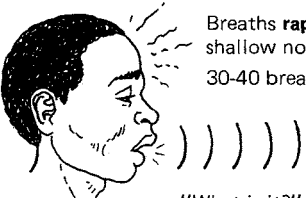

"What is it?"

(Rapid breathing that accompanies high fever? *WTND*, p. 32)
5. Breaths **very deep**, gasping for air, especially after mild exercise.

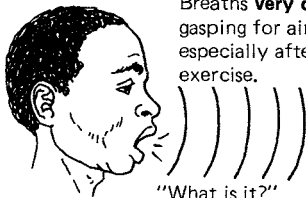

"What is it?"

(Severe anemia? *WTND*, p. 124. Heart problem? *WTND*, p.325)

6. Boiling or **bubbling** sound when breathing; cough. Breaths are otherwise normal.  
15-30 breaths/min.

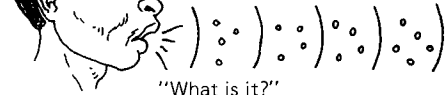

"What is it?"

(Bronchitis? *WTND*, p. 170)

7. Breathes out slowly, with difficulty. A **wheeze** or whistling sound with each breath.  
20-40 breaths/min.

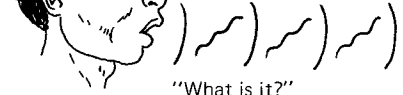

"What is it?"

(Asthma? *WTND*, p. 167,  
Chronic bronchitis? *WTND*, p. 170,  
Emphysema? *WTND*, p. 170)

**Shortness of breath with wheezing.**

8. Person breathes better when sitting up,

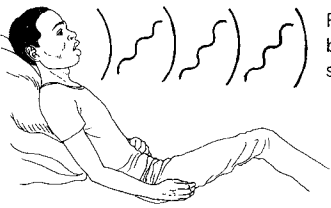

and worse when lying down.

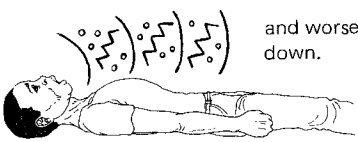

"What is it?"

(Cardiac asthma? *WTND*, p. 325)

9. Many coughs, one after another, with no ability to breathe in. At last a loud '**whoop**' as air enters.

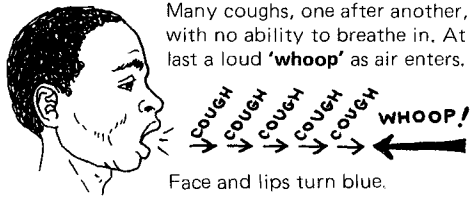

Face and lips turn blue.

"What is it?"

(Whooping cough? *WTND*, p. 313)

10. **Struggles for breath;** lips and skin turn blue. Does not breathe (or barely breathes).

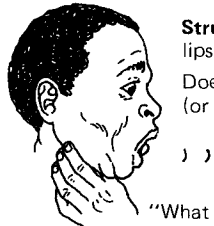

"What is it?"

(Choking—something stuck in the throat? *WTND*, page 79,  
Diphtheria? *WTND*, p. 313)

11. Breathes through the nose more or less normally. No fever.  
15-20 breaths/min.

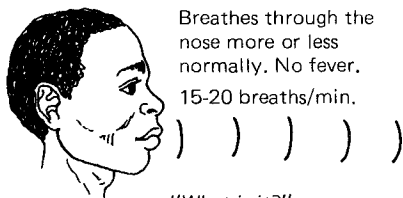

"What is it?"

(A normal, healthy person?)

With practice, health workers can learn to imitate the various noises (wheezing, rattling, whooping) and other signs (flaring nostrils, watering eyes, etc.) typical of different respiratory problems. For choking or asthma, the demonstrator can, by not breathing much, make his lips actually turn blue! Other signs can also be produced, such as 'sucking in' of the skin behind the collar bone and between the ribs when demonstrating asthma or emphysema.

Students should learn to notice and recognize all these signs. They should also learn to imitate them, so that they can teach others when they return to their villages.

**A GOOD TEACHER NEEDS TO BE A GOOD ACTOR!**

## ROLE PLAYING TO MOTIVATE COMMUNITY ACTION

Role playing has sometimes been used as part of a process to get a whole community of people thinking and taking action to meet their needs.

In Ghana, Africa, role plays were used to involve the people of Okorase in the town's development. To help with the role plays, health program leaders invited a popular cultural group that often performs at local ceremonies. First the group would help lead a 'one-day school' focusing on town problems. Then the group would stage role plays about one or two particular problems and their possible solutions. The following description of these events (somewhat shortened and simplified) is from an article by Larry Frankel in *World Education Reports*, April, 1981.

The cultural group members (with help from the project) purchased food and palm wine to entertain their guests. Then they invited the chief, his elders, and other members of the community to attend the 'one-day school'. After the traditional ceremonies and welcoming speeches, they gave the entire morning to small group discussions of the town's problems and their possible solutions. Each group had a discussion leader whose job was to see that everyone participated freely so that the 'big men' didn't dominate.

Before stopping for lunch, each small group was asked to choose a single problem, one that they considered serious but also solvable by the people's own efforts. The small groups then joined together to choose one or two problems and propose realistic solutions.

After lunch all the people were excused, except the cultural group members. Everyone thanked the chief and elders for their attendance and their help in trying to make the problem's solution a reality.

The cultural group spent the afternoon preparing and practicing two role plays or brief skits. They wanted to show as dramatically and humorously as possible why each problem was important and what could be done about it. In the evening, the chief had the 'gong gong' beater call the entire town to a free show. The role plays were performed, along with drumming, singing, and dancing.

The role plays in Okorase focused on two problems: unhealthy shitting habits and the lack of a health clinic.

In **the first role play**, a big shot from Accra (the capital) returns to visit his birthplace, Okorase. He has come to donate a large sum of money to the town development committee. Feeling nature's call, he seeks a place to relieve himself. When he finds only bushes, he becomes increasingly discomfited. His distress amuses several villagers, who wonder aloud why the bush is no longer good enough for him. The desperation of the actor playing the big shot had the people in the audience laughing until they cried.



Finally, the big shot flees Okorase without donating any money. Later, each of the people who laughed at him falls ill with some sort of sickness carried in human shit. So now the villagers become interested in trying a suggested solution: using low-cost water-sealed toilets to keep flies off the shit.

As a result of this role play and the discussion that followed, a local mason volunteered to be trained in the construction of toilet bowls. Cement was donated by the People's Educational Association (a private Ghanaian agency). Soon a profitable local industry was started, making water-sealed bowls for Okorase and surrounding villages.



In **the second role play**, a concerned group of villagers approaches the chief for help in starting a clinic. But the chief is not interested. He argues that medical attention is available in Koforidua, only four miles away.

During this discussion, a messenger bursts in and throws himself at the chief's feet. The chief's son has just been bitten by a poisonous snake! Everyone rushes to find a way to get the boy to the hospital in Koforidua, but before a vehicle can be located, the boy dies.

In his grief, the chief sees the error of his ways. He gathers the townspeople together and begs them to contribute money and labor to build a clinic so that no other parent will have to suffer as he has. He also appoints some villagers to negotiate with the regional medical officers for drugs and personnel.

As it happened, the real village chief of Okorase had recently lost a very well-liked relative. This made the role play extra powerful. The people of Okorase determined to build their own clinic and to collect some money for medicines.

The new clinic was soon built. For the ceremony to celebrate its opening, officials from the regional government and a foreign agency, as well as newspaper and television reporters, were invited. On this occasion, the village cultural group put on another, more carefully planned skit telling the story of a young girl who died of snakebite because the clinic had no electricity and so could not refrigerate antitoxin. The skit was presented as a community request to the authorities and development agencies to introduce electricity into their town. As a result, negotiations are presently taking place between the village and the Ministry. There is a possibility that electricity may actually come to Okorase.

---

This example from Ghana shows how role plays were used to motivate villagers to take action to meet their health needs. Finally, role plays (or skits) were even used to activate the government in the village's behalf.

The use of more organized role plays or skits in the form of 'Village Theater' is explored in Chapter 27.